

GL-1, 2, 3

Light Control PIR Detectors

Visonic®

Installation Instructions

1. INTRODUCTION

The **GENIE LITE (GL)** outdoor/ indoor light controller contains a passive infrared motion detector which operates lights for a preselected period, after detecting movement of an object in its field of view.

The object may be a human being, an animal or an automobile. The **GL** deters intruders, welcomes guests, promotes personal safety and saves on security lighting costs.

What is the size of the area protected by Genie Lite?

The standard GL-1 pattern has 90° fan shape with a radius of 12 m (40 ft). The range control allows adjustment from full to half range (see Figures 1 and 6).

Absolute range is affected by temperature variations. The specified range is typical and based on annual averages, and will be reasonably accurate most of the year.

Can I operate lights manually?

Of course! - refer to Figure 5 for wiring information

How long will lights remain on after movement is detected?

The ON time of the light is adjustable from approximately 4 seconds to 5 minutes. It automatically restarts each time motion

is detected. For time adjustment, see Figure 6. The time is increased when you turn the control clockwise (CW).

If motion is continuous, the light(s) will remain ON until no motion is detected and the timer has the opportunity to time out.

Does the GL operate day and night?

No, the **GL** has a day/night photocell sensor designed to enable the unit during dark hours only (see Figure 6). A light level control allows you to select the ambient light conditions at which the GL will be automatically enabled. Turning the control counterclockwise (CCW) will shift the "activation threshold" closer to total darkness.

Conversely, the **GL** can be enabled during daylight hours (for testing etc.), by turning the light level control maximum clockwise (CW).

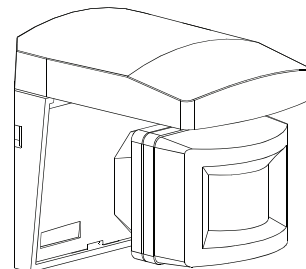

2. SPECIFICATIONS

OPTICAL

Detection method: Passive infrared

Detection Patterns:

Four detection patterns are available:

GL-1: Wide Angle - 90°

This model provides 3 layers of detection zones. Maximum coverage is 12 x 12 m (40 x 40 ft), 90°. The wide angle lens is the standard pattern supplied with the GENIE-LITE. Model GL-1 is ideal for corner mounting. Recommended mounting height: 2 to 4.5 m (7 to 15 ft). For best detection it is advisable to mount the unit between 2 and 3 m (7-10 ft).

GL-2: Long-Range - 27 m (90 ft)

This model provides a single layer detection zone. Maximum range is 27 x 3 m (90 x 10 ft). This lens is specially designed for long range and narrow areas such as walkways and long walls. Recommended mounting height: 1.6 to 2.5 m (5 to 8 ft).

GL-3: Ultra-Wide Angle - 145°

This model provides three layers of detection zones. Maximum range is 12 x 18 m (40 x 60 ft), 145°. For best detection it is

recommended to mount the unit between 2-3 m (7-10 ft). Recommended mounting height: 2 to 4.5 m (7 to 15 ft).

ELECTRICAL

Operating Voltage: 110 VAC to 240 VAC 50/60 Hz.

Switching Capacity: 8 A / 240 VAC @ resistive load (cos ϕ = 1); 5A / 120 or 240 VAC @ inductive load (cos ϕ = 0.4).

GENERAL DATA

Lights On Timer: 4 seconds to 5 minutes, adjustable.

Photocell: Total darkness to full daylight, adjustable.

Detection Area: Full to half range, adjustable.

Compliance with Standards: Meets safety standard EN 60950

Operating Temperature: -20°C to 50°C (-4°F to 122°F).

Dimensions: 109 x 87 x 122 mm (4-5/16 x 3-7/16 x 4-13/16 in.)

Weight: 254 g (8.2 oz).

Color: White

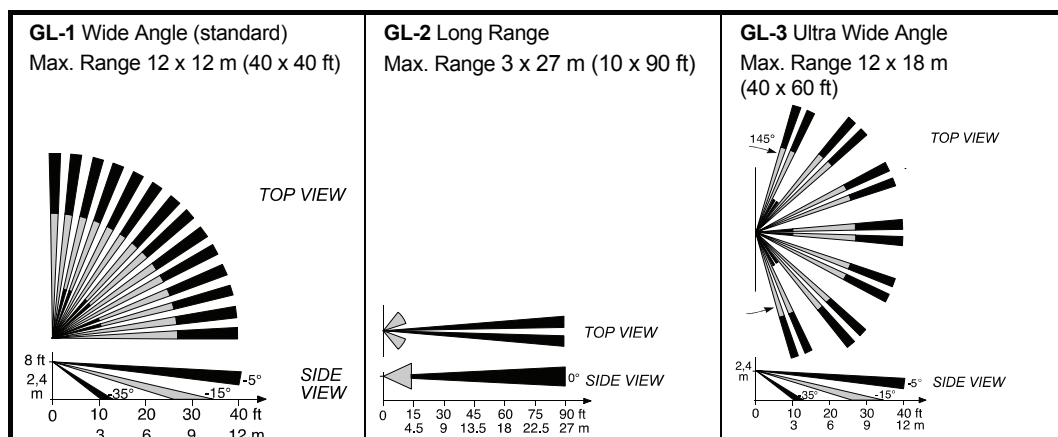

Figure 1. Coverage Patterns

3. INSTALLATION

3.1 Mounting

The **GL** can be installed directly on a wall (surface mount) or in a corner. Always mount the unit on a firm and stable surface. Passive infrared detectors operate best when installed so that movement is across the coverage pattern. Movement toward or away from the **GL** will also be detected, but not as precisely as movement across the coverage pattern.

- Select the mounting location so that the expected motion will cross the beams of the coverage pattern.
- Select the appropriate mounting height. The following suggestions are mentioned to reduce the possibility of nuisance triggering.

Avoid installing the **GL** :

- Above or below the recommended installation height.
 - On a surface that will be affected by wind.
 - Looking into the sun. This could cause the unit to malfunction.
 - So that it looks at shrubs, trees, water or any object that could move or change temperature rapidly.
 - Above warm air vents or in the exhaust of a fan.
 - So that it faces the light that it is controlling.
 - So that the detection pattern is on a neighboring property.
- Open the front cover by gently inserting a quarter-inch screwdriver in the slot at the bottom of the unit. Apply a downward pressure on the screwdriver handle until the cover swings outward and removes easily (Figure 2).
 - Mount the base in the location selected for optimum coverage. Use the four knockouts at the back of the base for surface mount and the four knockouts on the angled sides for corner mount (see Figure 3). The unit must be fastened firmly to avoid possible vibrations.
 - Even though the **GL** case is weather resistant, protect the unit from rain, snow and harsh sunlight as much as possible.

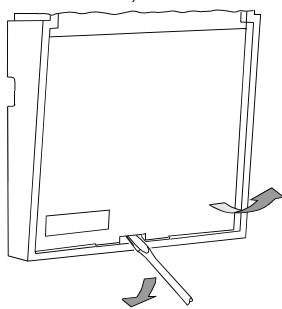

Figure 2. Opening the Front Cover

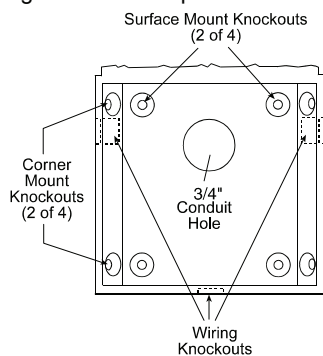

Figure 3. The GL Base

3.2 Wiring

Only three terminal block connections are required. See Figures 4 and 5.

P - Power live (~) brown.

N - Neutral (0) blue.

SP - Switched Power to load, red.

Maximum switching capability:

With resistive load ($\cos \phi = 1$): 8 A / 230 or 120 VAC

With inductive load ($\cos \phi = 0.4$): 5A / 230 or 120 VAC

The power live should be protected by a 15A fuse at the house circuit breaker panel.

ATTENTION! Conductor cross section should be at least 1 sq. mm (AWG 17).

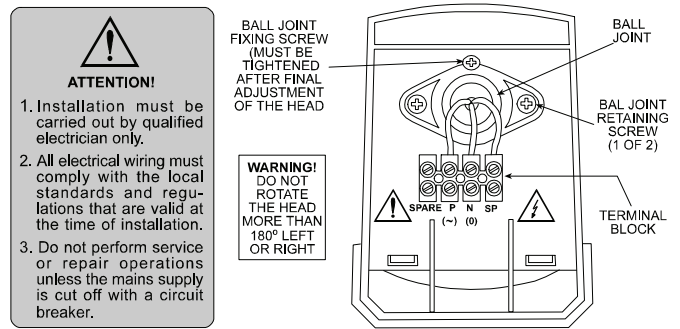

Figure 4. Head with Cover Removed

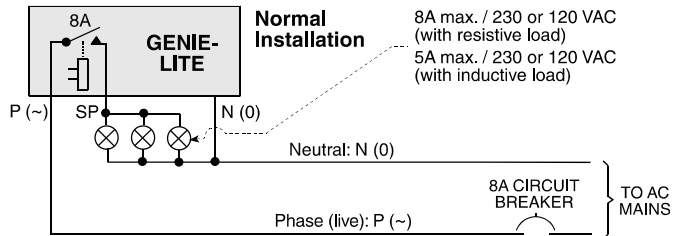

Figure 5. Wiring Configurations

- Unscrew the screw at the front of the unit and remove the head cover to expose the terminal block. The correct way to do it is to pull up the front edge of the cover, and then work the rear edge loose (the rear edge of the cover has two internal bumps that engage with small dents in the main body of the **GL**).
- There are three wiring knockouts (two on the sides, one on the bottom - Fig. 3), and an open hole which accommodates a 3/4" conduit fitting.
- Feed the wiring through the selected entryway, pass the wiring upward through the opening in the head, and connect the wires to the terminal block in the head (see Fig. 4 and 5).

3.3 Walk Testing

- Apply mains power and allow 5 minutes for the unit to warm up and stabilize.
- Set the timer control to minimum (max. counterclockwise - see Fig. 6), to obtain an operating time of about 4 seconds.
- Rotate the light level control maximum clockwise (Fig. 6), to make the unit operate during daylight hours. This temporary setting is necessary for walk testing.
- Set the range control maximum clockwise to obtain maximum range (Fig. 6).
- Slightly release the two ball joint retaining screws in the head (Fig. 4) and position the detector in the direction of the area to be covered.
- GL** observes a pattern which is determined by its lens. It cannot see through solid objects, so be sure to remove them from the field of view

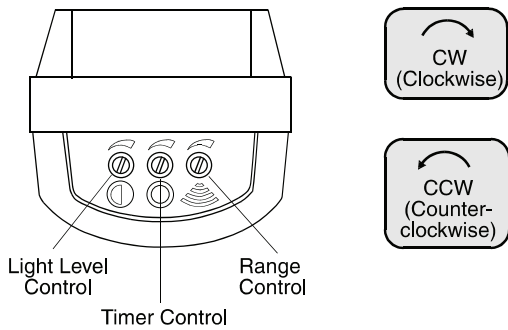

Figure 6. Adjustments

- G. Observe the detector from the front and ensure that it is level, so that the entire coverage pattern is used, across its full width. See Figure 7.

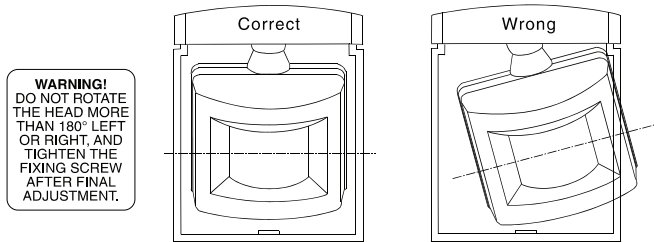

Figure 7. Positioning the PIR

- H. Refer to the coverage pattern which applies to your unit. Position the detector so that an approximate center line through the unit will intersect the center of your body at the maximum distance where movement is to be detected (see figure 8). Position yourself outside the detection pattern. Walk slowly ACROSS the coverage pattern (in opposite directions), to verify proper positioning and detection. Readjust if necessary.
- I. Tighten the two ball joint retaining screws and replace the head cover.
- J. Adjust the timer control for the appropriate time desired for "lights on". Do not move in the detecting area while measuring the time.
- K. Set the ambient light level control to mid-position. A more accurate adjustment can be made in the evening at the actual ambient light at which you want the GENIE-LITE to be automatically enabled (CCW = darker environment, CW = brighter environment).

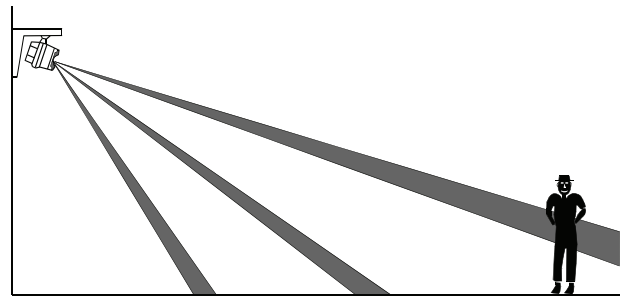

Figure 8. Aiming the PIR

3.4 GENIE-LITE Troubleshooting

Lights will not turn on

- Verify that the ambient light level control is set for activating the unit at full daylight (max. clockwise).
- Verify that all lamps, bulbs, etc. are seated well and secured in their sockets.
- Check the fuse or circuit breaker panel.
- Check that all wiring and connections are correct. Refer to Figures 4 and 5.
 - The live supply wire (phase) should be connected to the **P** (~) terminal of the GL.
 - The neutral supply wire should be connected to the **N** (0) terminal of the GL and to the neutral input of the lighting device(s).
 - The switched phase (**SP**) terminal of the GL should be connected to the live input of the lighting device(s).

Lights will not turn off

- Check the setting of the timer control. Set it for minimum operating time (maximum counterclockwise).
- Make sure that objects are not moving in the units field of view.
- Verify that the **GENIE-LITE** is mounted on a stable surface.

Lights switch on during rainstorms

Sudden changes in temperature due to rain could cause the detector to operate, turning lights on. Reduce the range control setting and walk-test again.

Lights switch on during the day

The ambient light level control might be inadvertently set to the maximum CW (clockwise) position. If so, turn it gradually CCW (counterclockwise) to obtain the desired level of darkness at which the unit will be automatically enabled.

WARRANTY

Visonic Limited (the "Manufacturer") warrants this product only (the "Product") to the original purchaser only (the "Purchaser") against defective workmanship and materials under normal use of the Product for a period of twelve (12) months from the date of shipment by the Manufacturer.

This Warranty is absolutely conditional upon the Product having been properly installed, maintained and operated under conditions of normal use in accordance with the Manufacturers recommended installation and operation instructions. Products which have become defective for any other reason, according to the Manufacturers discretion, such as improper installation, failure to follow recommended installation and operational instructions, neglect, willful damage, misuse or vandalism, accidental damage, alteration or tampering, or repair by anyone other than the manufacturer, are not covered by this Warranty.

The Manufacturer does not represent that this Product may not be compromised and/or circumvented or that the Product will prevent any death and/or personal injury and/or damage to property resulting from burglary, robbery, fire or otherwise, or that the Product will in all cases provide adequate warning or protection. The Product, properly installed and maintained, only reduces the risk of such events without warning and it is not a guarantee or insurance that such events will not occur.

THIS WARRANTY IS EXCLUSIVE AND EXPRESSLY IN LIEU OF ALL OTHER WARRANTIES, OBLIGATIONS OR LIABILITIES, WHETHER WRITTEN, ORAL, EXPRESS OR IMPLIED, INCLUDING ANY WARRANTY OF MERCHANTABILITY OR FITNESS FOR A PARTICULAR PURPOSE, OR OTHERWISE. IN NO CASE SHALL THE MANUFACTURER BE LIABLE TO ANYONE FOR ANY CONSEQUENTIAL OR INCIDENTAL DAMAGES FOR BREACH OF THIS WARRANTY OR ANY OTHER WARRANTIES WHATSOEVER, AS AFORESAID.

THE MANUFACTURER SHALL IN NO EVENT BE LIABLE FOR ANY SPECIAL, INDIRECT, INCIDENTAL, CONSEQUENTIAL OR PUNITIVE DAMAGES OR FOR LOSS, DAMAGE, OR EXPENSE, INCLUDING LOSS OF USE, PROFITS, REVENUE, OR GOODWILL, DIRECTLY OR INDIRECTLY ARISING FROM PURCHASER'S USE OR INABILITY TO USE THE PRODUCT, OR FOR LOSS OR DESTRUCTION OF OTHER PROPERTY OR FROM ANY OTHER CAUSE, EVEN IF MANUFACTURER HAS BEEN ADVISED OF THE POSSIBILITY OF SUCH DAMAGE.

THE MANUFACTURER SHALL HAVE NO LIABILITY FOR ANY DEATH, PERSONAL AND/OR BODILY INJURY AND/OR DAMAGE TO PROPERTY OR OTHER LOSS WHETHER DIRECT, INDIRECT, INCIDENTAL, CONSEQUENTIAL OR OTHERWISE, BASED ON A CLAIM THAT THE PRODUCT FAILED TO FUNCTION.

However, if the Manufacturer is held liable, whether directly or indirectly, for any loss or damage arising under this limited warranty, **THE MANUFACTURER'S MAXIMUM LIABILITY (IF ANY) SHALL NOT IN ANY CASE EXCEED THE PURCHASE PRICE OF THE PRODUCT**, which shall be fixed as liquidated damages and not as a penalty, and shall be the complete and exclusive remedy against the Manufacturer.

When accepting the delivery of the Product, the Purchaser agrees to the said conditions of sale and warranty and he recognizes having been informed of.

Some jurisdictions do not allow the exclusion or limitation of incidental or consequential damages, so these limitations may not apply under certain circumstances.

The Manufacturer shall be under no liability whatsoever arising out of the corruption and/or malfunctioning of any telecommunication or electronic equipment or any programs.

The Manufacturers obligations under this Warranty are limited solely to repair and/or replace at the Manufacturer's discretion any Product or part thereof that may prove defective. Any repair and/or replacement shall not extend the original Warranty period. The Manufacturer shall not be responsible for dismantling and/or reinstallation costs. To exercise this Warranty the Product must be returned to the Manufacturer freight pre-paid and insured. All freight and insurance costs are the responsibility of the Purchaser and are not included in this Warranty.

This warranty shall not be modified, varied or extended, and the Manufacturer does not authorize any person to act on its behalf in the modification, variation or extension of this warranty. This warranty shall apply to the Product only. All products, accessories or attachments of others used in conjunction with the Product, including batteries, shall be covered solely by their own warranty, if any. The Manufacturer shall not be liable for any damage or loss whatsoever, whether directly, indirectly, incidentally, consequentially or otherwise, caused by the malfunction of the Product due to products, accessories, or attachments of others, including batteries, used in conjunction with the Products. This Warranty is exclusive to the original Purchaser and is not assignable.

This Warranty is in addition to and does not affect your legal rights. Any provision in this warranty which is contrary to the Law in the state or country where the Product is supplied shall not apply.

Warning: The user must follow the Manufacturer's installation and operational instructions including testing the Product and its whole system at least once a week and to take all necessary precautions for his/her safety and the protection of his/her property.

1/08



W.E.E.E. Product Recycling Declaration

For information regarding the recycling of this product you must contact the company from which you originally purchased it. If you are discarding this product and not returning it for repair then you must ensure that it is returned as identified by your supplier. This product is not to be thrown away with everyday waste. Directive 2002/96/EC Waste Electrical and Electronic Equipment.

The technical documentation as required by the European Conformity Assessment procedure is kept at:

UNIT 6 MADINGLEY COURT CHIPPENHAM DRIVE KINGSTON MILTON KEYNES MK10 0BZ. Telephone number: 0870 7300800, Fax number: 0870 7300801



VISONIC LTD. (ISRAEL): P.O.B 22020 TEL-AVIV 61220 ISRAEL. PHONE: (972-3) 645-6789, FAX: (972-3) 645-6788
VISONIC INC. (U.S.A.): 65 WEST DUDLEY TOWN ROAD, BLOOMFIELD CT. 06002-1376. PHONE: (860) 243-0833, (800) 223-0020. FAX: (860) 242-8094
VISONIC LTD. (UK): UNIT 6 MADINGLEY COURT CHIPPENHAM DRIVE KINGSTON MILTON KEYNES MK10 0BZ. TEL: (0870) 7300800 FAX: (0870) 7300801
PRODUCT SUPPORT: (0870) 7300830
VISONIC GmbH (D-A-CH): KIRCHFELDSTR. 118, D-40215 DÜSSELDORF, TEL.: +49 (0)211 600696-0, FAX: +49 (0)211 600696-19
VISONIC IBERICA: ISLA DE PALMA, 32 NAVE 7, POLÍGONO INDUSTRIAL NORTE, 28700 SAN SEBASTIÁN DE LOS REYES, (MADRID), ESPAÑA. TEL (34) 91659-3120, FAX (34) 91663-8468. www.visonic-iberica.es
INTERNET: www.visonic.com
©VISONIC LTD. 2009 GL1,2,3 DE1716- (Rev 2, 11/09)

